

# LUCAS GIRLING - BREMBO HYDRAULIC SERIES

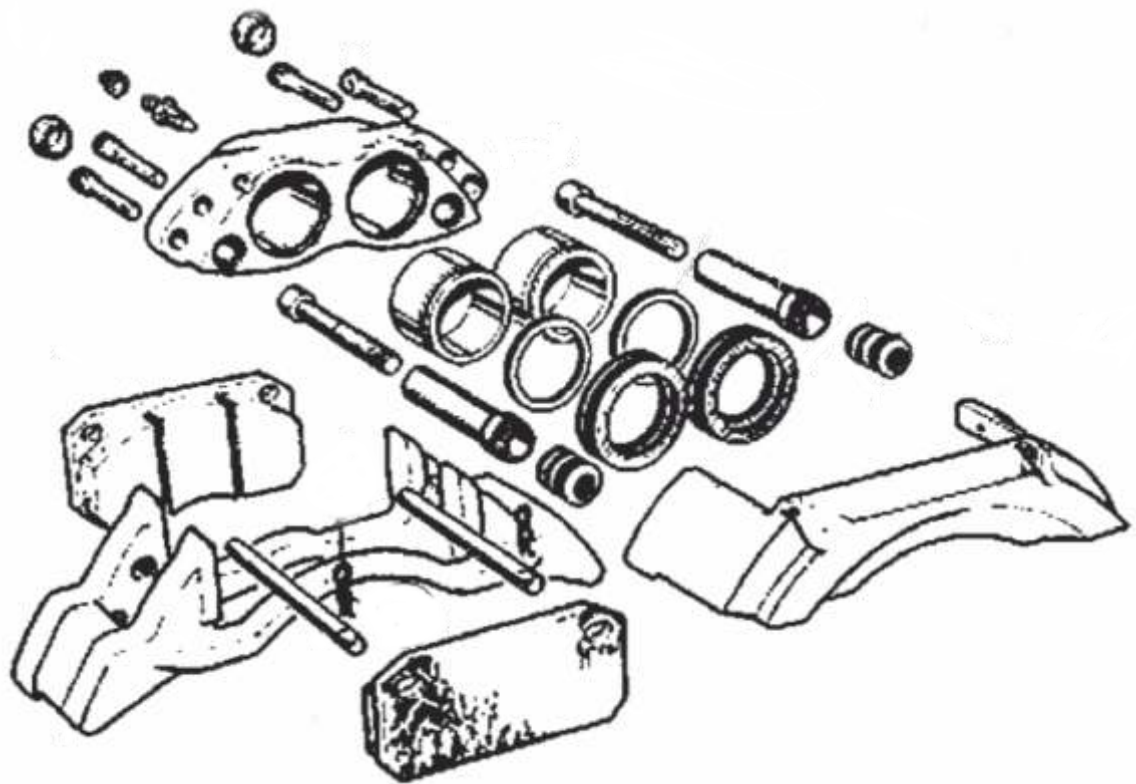



**Kit No** : BTG80001  
**OEM No** : SP8570 - SJ1032  
 Application : Girling Type  
 Description : Setting Shaft Girling-Lucas  
 1- BTT431 Setting Shaft  
 2- BTC77 Nut



**Kit No** : BTG80003  
**OEM No** : SJ1022 - 93161475  
 Application : Girling  
 Description : Caliper Guide & Bush Repair Kit  
 1- BTT344 Guide Pin Ø20x71mm  
 2- BTC75 Screw M12x1,25x85mm.  
 3- BTK111 Rubber Seal  
 4- BTS89 Metal Cap Ø24x12mm.  
 5- BTC76 Adjuster Nut M14X10mm.



**Kit No** : BTG80011  
**OEM No** : SJ1035 - ST1153 - 1522179 - 93161029 - 93161472 - 000.420.0476  
 Application : Hydraulic MERITOR / ROR, 58B58 60B60 - 68B68 TYPE CALIPER LRG612/LRG613  
 Description : Caliper Repair Kit  
 1- BTT351 Guide Pin Ø18x66 mm.  
 2- BTC81 Pin Bolt M8x1.25x70 mm.  
 3- BTK111 Pin Rubber Bush  
 4- BTS89 Metal Cap Ø24x12mm.



**Kit No** : BTG80018  
**OEM No** : SP8566 - 1522175 - X1857625 - 5001.829.894  
 Application : Girling  
 Description : Caliper Repair Kit  
 1- BTK111 Pin Rubber Bush  
 2- BTS89 Metal Cap Ø24x12mm.  
 3- BTC76 Adjuster Nut M14X10mm.



**Kit No** : BTG80012  
**OEM No** : SP8565 - 1522081 - 8124737 - 69028720 - X1857624 - 3090851  
 Application : Girling  
 Description : Caliper Guide & Bush Repair Kit  
 1- BTT344 Guide Pin Ø20x71mm  
 2- BTC75 Screw M12x1,25x85mm.  
 3- BTK111 Rubber Seal  
 4- BTS90 Metal Cap Ø22x12mm.  
 5- BTS91 Metal Cap Ø22x8mm.



**Kit No** : BTG80015  
**OEM No** : SJ1034 - 93161473 - 93161037  
 Application : Hydraulic MERITOR / ROR, 58B58 - 60B60 - 68B68 TYPE CALIPER  
 Description : Caliper Repair Kit  
 1- BTT351 Guide Pin Ø18x66 mm.  
 2- BTC81 Pin Bolt M8x1.25x70 mm.  
 3- BTK111 Pin Rubber Bush  
 4- BTS89 Metal Cap Ø24x12mm.  
 5- BTC76 Adjuster Nut M14X10mm.



**Kit No** : BTG80004

**OEM No** : SJ1033 - 93161034 - 93161471

**Application** : Hydraulic, MERITOR / ROR, 58B58  
60B60 - 68B68 TYPE CALIPER

**Description** : Caliper Repair Kit Overhaul

- 1- BTK121 Boot
- 2- BTK122 Square Ring Ø68x3mm.
- 3- BTK111 Pin Rubber Bush
- 4- BTS89 Metal Cap Ø24x12mm.
- 5- BTC76 Adjuster Nut M14X10mm.
- 6- BTK123 O-Ring Ø23x2,60mm.
- 7- BTK124 Square Ring Ø23x2,60mm.
- 8- BTK125 O-Ring Ø34x3mm.
- 9- BTK126 Boot Ø32x6,40mm.
- 10- BTK127 Plastic Ø45x5mm.
- 11- BTK12 Snap Ring Ø42,50x1,70mm.
- 12- BTK13 Snap Ring Ø35x1,70mm.



**Kit No** : BTG80017

**OEM No** : SP9670 - 1522163 - 87DB2W302BA -  
69028710 - R200076

**Application** : Hydraulic MERITOR / ROR, 58B58 -  
60B60 - 68B68 TYPE CALIPER

**Description** : Caliper Repair Kit Overhaul

- 1- BTK121 Boot
- 2- BTK122 Square Ring Ø68x3mm.
- 3- BTK111 Pin Rubber Bush
- 4- BTS90 Metal Cap Ø22x12mm.
- 5- BTS91 Metal Cap Ø22x8mm.
- 6- BTK123 O-Ring Ø23x2,60mm.
- 7- BTK124 Square Ring Ø23x2,60mm.
- 8- BTK125 O-Ring Ø34x3mm.
- 9- BTK126 Boot Ø32x6,40mm.
- 10- BTK127 Plastic Ø45x5mm.
- 11- BTK12 Snap Ring Ø42,50x1,70mm.
- 12- BTK13 Snap Ring Ø35x1,70mm.



**Kit No** : BTG80013

**OEM No** : SP8902 - 1522173 - 000.421.1463

**Application** : Hydraulic MERITOR / ROR, 58B58 -  
60B60 - 68B68 TYPE CALIPER

**Description** : Caliper Repair Kit

- 1- BTT352 Guide Pin Ø20x80 mm.
- 2- BTC82 Pin Bolt M8x1.25x95 mm.
- 3- BTK111 Pin Rubber Bush
- 4- BTC76 Adjuster Nut M14X10mm.



**Kit No** : BTG80020

**OEM No** : SJ1037 - 91361028 - 93161028

**Application** : Hydraulic MERITOR / ROR, 58B58 -  
60B60 - 68B68 TYPE CALIPER

**Description** : Caliper Repair Kit

- 1- BTK128 Boot
- 2- BTK129 Square Ring Ø60x3mm.
- 3- BTK111 Pin Rubber Bush



**Kit No** : BTG80014

**OEM No** : SJ1030 - 93161036 - 93191505

**Application** : Hydraulic MERITOR / ROR,58B58 - 60B60 - 68B68 TYPE CALIPER- LRG612/LRG613

**Description** : Caliper Repair Kit Overhaul

- 1- BTK128 Boot
- 2- BTK129 Square Ring Ø60x3mm.
- 3- BTK111 Pin Rubber Bush
- 4- BTS89 Metal Cap Ø24x12mm.
- 5- BTC76 Adjuster Nut M14X10mm.
- 6- BTK123 O-Ring Ø23x2,60mm.
- 7- BTK124 Square Ring Ø23x2,60mm.
- 8- BTK125 O-Ring Ø34x3mm.
- 9- BTK126 Boot Ø32x6,40mm.
- 10- BTK127 Plastic Ø45x5mm.
- 11- BTK12 Snap Ring Ø42,50x1,70mm.
- 12- BTK13 Snap Ring Ø35x1,70mm.



**Kit No** : BTG80022

**OEM No** : SP8564 - 1522160 - 93161552 - R1800031 - 5001.014.701 - 3090937

**Application** : Hydraulic MERITOR / ROR,58B58 - 60B60 - 68B68 TYPE CALIPER- LRG508/LRG509/LRG502/LRG503

**Description** : Caliper Repair Kit Overhaul

- 1- BTK121 Boot
- 2- BTK122 Square Ring Ø68x3mm.
- 3- BTK111 Pin Rubber Bush
- 4- BTS90 Metal Cap Ø22x12mm.
- 5- BTS91 Metal Cap Ø22x8mm.



**Kit No** : BTG80016

**OEM No** : SP9669 - 1522162 - 87DB2W302CA - X2057635 - 3090939

**Application** : Hydraulic MERITOR / ROR,58B58 - 60B60 - 68B68 TYPE CALIPER- LRG608/LRG609

**Description** : Caliper Repair Kit Overhaul

- 1- BTK130 Boot
- 2- BTK131 Square Ring Ø58x3mm.
- 3- BTK111 Pin Rubber Bush
- 4- BTS90 Metal Cap Ø22x12mm.
- 5- BTS91 Metal Cap Ø22x8mm.
- 6- BTK123 O-Ring Ø23x2,60mm.
- 7- BTK124 Square Ring Ø23x2,60mm.
- 8- BTK125 O-Ring Ø34x3mm.
- 9- BTK126 Boot Ø32x6,40mm.
- 10- BTK127 Plastic Ø45x5mm.
- 11- BTK12 Snap Ring Ø42,50x1,70mm.
- 12- BTK13 Snap Ring Ø35x1,70mm.



**Kit No** : BTG80019

**OEM No** : SP8597 - 1522174 - 5001.014.679 - 5001.829.892

**Application** : Hydraulic MERITOR / ROR,58B58 - 60B60 - 68B68 TYPE CALIPER

**Description** : Caliper Repair Kit

- 1- BTK128 Pin Rubber Bush
- 2- BTK129 Square Ring Ø60x3mm.
- 3- BTK111 Pin Rubber Bush
- 4- BTS89 Metal Cap Ø24x12mm.



<b>Kit No</b>	: BTG80021
<b>OEM No</b>	: SP8567 - 1522161 - 3090938
<b>Application</b>	: Hydraulic MERITOR / ROR,58B58 - 60B60 - 68B68 TYPE CALIPER
<b>Description</b>	: Caliper Repair Kit Overhaul
1- BTK130	Boot
2- BTK131	Square Ring Ø58x3mm.
3- BTK111	Pin Rubber Bush
4- BTS90	Metal Cap Ø22x12mm.
5- BTS91	Metal Cap Ø22x8mm.



<b>Kit No</b>	: BTG80006
<b>OEM No</b>	: 000 423 0663
<b>Application</b>	: Sprinter 906 (Rear),LT,W 906
<b>Description</b>	: Caliper Repair Kit Brembo
1- BTT347	Pin Ø11.50x82mm.
2- BTT348	Pin Ø12.15x82mm.
3- BTC78	Pin Bolt M10x1.25x30mm.
4- BTK115	Pin Rubber Bush
5- BTK116	Pin Boot



<b>Kit No</b>	: BTG80009
<b>OEM No</b>	: 93161759 - 42534122
<b>Application</b>	: Brembo
<b>Description</b>	: Caliper Repair Kit
1- BTT349	Guide Pin Ø22x90mm
2- BTC79	Screw M12x1,75x110mm.
3- BTK120	Pin Boot



<b>Kit No</b>	: BTG80010
<b>OEM No</b>	: 42559195
<b>Application</b>	: Brembo
<b>Description</b>	: Caliper Repair Kit (New Model)
1- BTT350	Guide Pin Ø22x98mm
2- BTC80	Screw M12x1,75x120mm.
3- BTK120	Pin Boot



<b>Kit No</b>	: BTG80007
<b>OEM No</b>	: BrakingTech Only
<b>Application</b>	: New Gen. Brembo,Iveco Daily,Man,Daf,MB.
<b>Description</b>	: Seals For Ø60/75-76mm Pistons
1- BTK117	Piston Seal



<b>Kit No</b>	: BTG80008
<b>OEM No</b>	: BrakingTech Only
<b>Application</b>	: New Type Brembo,Iveco Daily,Man,Daf,MB.
<b>Description</b>	: New Brembo Boot for Pins Ø22x98 mm.
1- BTK118	Pin Boot



<b>Kit No</b>	: BTG80005
<b>OEM No</b>	: MB 000 420 0054 - 000 421 0850 68064359AA
<b>Application</b>	: Sprinter 209 CDI, 315 CDI, 318 CDI, Sprinter 906.W 906
<b>Description</b>	: Caliper Repair Kit Brembo
1- BTT345	Guide Pin Ø18x66 mm.
2- BTT346	Guide Pin Ø18x66 mm.
3- BTC77	Pin Bolt M8x1.25x70 mm.
4- BTK112	Pin Boot
5- BTK113	Pin Rubber Bush
6- BTK114	Rubber Plug



<b>Kit No</b>	: BTG80025
<b>OEM No</b>	: BrakingTech Only
<b>Application</b>	: Brembo Type
<b>Description</b>	: Adjusting Mechanism
1- BTT435	Adjustment Slot
2- BTT436	Setting Screw



<b>Kit No</b>	: BTG80026
<b>OEM No</b>	: BrakingTech Only
<b>Application</b>	: Brembo Type
<b>Description</b>	: Setting Screw
1- BTT436	Screw



<b>Kit No</b>	: BTG80042
<b>OEM No</b>	: ST1154 - 0004218386
<b>Application</b>	: Meritor Hydraulic
<b>Description</b>	: Wedge Repair Kit
1- BTK111	Pin Rubber Bush
2- BTS89	Metal Cap Ø24x12mm.
3- BTC76	Adjuster Nut M14X10mm.



<b>Kit No</b>	: BTG80002
<b>OEM No</b>	: SP8570, SJ1032
<b>Application</b>	: Brembo Type
<b>Description</b>	: Setting Shaft Brembo
1- BTT433	Setting Shaft



<b>Kit No</b>	: BTG80002-01
<b>OEM No</b>	: SP8570, SJ1032
<b>Application</b>	: Brembo Type
<b>Description</b>	: Setting Shaft Brembo
1- BTT434	Setting Shaft



**Kit No** : BTG80028  
**OEM No** : BrakingTech Only  
 Application : Brembo Type  
 Description : Wedge Repair Kit  
 1- BTK156 Felt  
 2- BTT437 Adjustment Wedge



**Kit No** : BTG80030  
**OEM No** : BrakingTech Only  
 Application : Brembo Type  
 Description : Adjustment Wedge  
 1- BTT366 Wedge



**Kit No** : BTG80029  
**OEM No** : BrakingTech Only  
 Application : Brembo Type  
 Description : Adjustment Wedge  
 1- BTT365 Wedge



**Kit No** : BTG80027  
**OEM No** : BrakingTech Only  
 Application : Brembo Type  
 Description : Spring of Mechanism  
 1- BTY42 Spring



**Kit No** : BTG80039  
**OEM No** : BrakingTech Only  
 Application : Brembo Type  
 Description : Bearing of Wedge  
 1- BTR36 Bearing



**Kit No** : BTG80032  
**OEM No** : BrakingTech Only  
 Application : Brembo Type  
 Description : Wedge Grooved  
 1- BTT368 Wedge

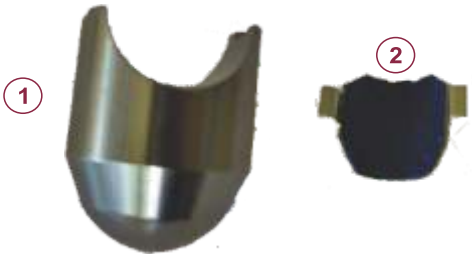

**Kit No** : BTG80034  
**OEM No** : BrakingTech Only  
 Application : Brembo Type  
 Description : Wedge Repair Kit  
 1- BTT391 Adjustment Wedge  
 2- BTB32 Bush



**Kit No** : BTG80071  
**OEM No** : BrakingTech Only  
 Application : Brembo Type  
 Description : Wedge  
 1- BTT392 Wedge (Ø29.50 mm.)



**Kit No** : BTG80072  
**OEM No** : BrakingTech Only  
 Application : Brembo Type, Iveco Daily, Daf LF  
 Description : Spring Washer  
 1- BTT438 Washer

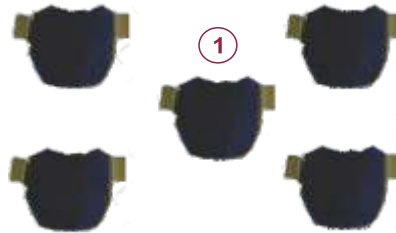

**Kit No** : BTG80035  
**OEM No** : BrakingTech Only  
 Application : Brembo Type  
 Description : Shaft Bearing Bush  
 1- BTB32 Bush



**Kit No** : BTG80038  
**OEM No** : BrakingTech Only  
 Application : Brembo Type  
 Description : Locking Screw Kit  
 1- BTC80 Screw M12x1.25x45



**Kit No** : BTG80037  
**OEM No** : BrakingTech Only  
 Application : Brembo Type  
 Description : Locking Circlip Kit  
 1- BTK14 Circlip - Big  
 2- BTK15 Circlip - Small



**Kit No** : BTG80036  
**OEM No** : BrakingTech Only  
 Application : Brembo Type  
 Description : Shaft Setting Bush  
 1- BTB35 Bush





**Kit No** : BTG80040  
**OEM No** : 13.0471-5405.2, A000.423.00.75  
 0004230075BA - 0004230075  
 4230075 - 13-0471-5405-2

**Application** : ATE, MERCEDES. MB-TRAC (BM 440)  
 65/70/700/800/900 MERCEDES.  
 MB-TRAC (BM 441) 1000 MERCEDES.  
 UNIMOG (BM 403) 54/66/72/800

**Description** : Caliper Brake Repair Kit



**Kit No** : BTG80031  
**OEM No** : BrakingTech Only

**Application** : Hydraulic Caliper

**Description** : Caliper Piston

1- BTT367 Piston (Ø60x63mm)



**Kit No** : BTG80041  
**OEM No** : BrakingTech Only

**Application** : Hydraulic Caliper

**Description** : Wedge Repair Kit

1- BTT369 Piston (Ø54x63 mm.)  
 2- BTT370 Piston (Ø54x63 mm.)  
 3- BTK138 Boot  
 4- BTK139 Seal



**Kit No** : BTG80050  
**OEM No** : BrakingTech Only

**Application** : Brembo Type

**Description** : Wedge Repair Kit

1- BTS111 Metal Shield  
 2- BTS112 Cover Shield Small  
 3- BTS113 Cover Shield Large  
 4- BTK151 Square Ring  
 5- BTK152 Boot  
 6- BTK153 Square Ring  
 7- BTK154 Boot



**Kit No** : BTG80024  
**OEM No** : BrakingTech Only

**Application** : Hydraulic Caliper

**Description** : Caliper Piston Kit (New Variant)

1- BTT363 Piston Ø60 x Ø22 x 76 mm.  
 2- BTT364 Piston Ø60 x 75 mm.



**Kit No** : BTG80023  
**OEM No** : 42 53 41 21

**Application** : Hydraulic Caliper

**Description** : Caliper Piston Kit

1- BTT361 Piston Ø60 x Ø22 x 65 mm.  
 2- BTT362 Piston Ø60 x 63 mm.



**Kit No** : BTG80033  
**OEM No** : BrakingTech Only  
 Application : Hydraulic Caliper  
 Description : Hydraulic Piston  
 1- BTT430 Piston (Ø60x63mm)



**Kit No** : BTG80043  
**OEM No** : BrakingTech Only  
 Application : Hydraulic Caliper  
 Description : Hydraulic Piston  
 1- BTT403 Piston (Ø68 x Ø22 x 63.50 mm)



**Kit No** : BTG80048  
**OEM No** : BrakingTech Only  
 Application : Hydraulic Caliper  
 Description : Hydraulic Piston  
 1- BTT408 Piston (Ø54 x 63.50 mm.)



**Kit No** : BTG80045  
**OEM No** : BrakingTech Only  
 Application : Hydraulic Caliper  
 Description : Hydraulic Piston  
 1- BTT405 Piston (Ø56 x 36 mm)



**Kit No** : BTG80047  
**OEM No** : BrakingTech Only  
 Application : Hydraulic Caliper  
 Description : Hydraulic Piston  
 1- BTT407 Piston (Ø48 x 58.00 mm)



**Kit No** : BTG80049  
**OEM No** : BrakingTech Only  
 Application : Hydraulic Caliper  
 Description : Hydraulic Piston  
 1- BTT409 Piston (Ø60 x Ø28 x 62 mm.)

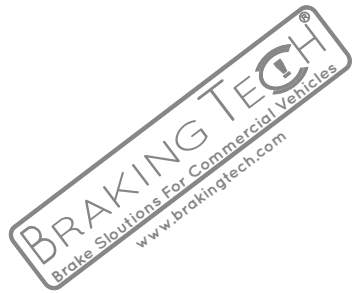

**Kit No** : BTG80044  
**OEM No** : BrakingTech Only  
 Application : Hydraulic Caliper  
 Description : Hydraulic Piston  
 1- BTT404 Piston (Ø60 x Ø22 x 65 mm.)



**Kit No** : BTG80052  
**OEM No** : BrakingTech Only  
 Application : Hydraulic Caliper  
 Description : Hydraulic Piston  
 1- BTT411 Piston (Ø68 x Ø28 x 62 mm.)



**Kit No** : BTG80054  
**OEM No** : BrakingTech Only  
 Application : Hydraulic Caliper  
 Description : Hydraulic Piston  
 1- BTT413 Piston (Ø60 x Ø28 x 64 mm.)



**Kit No** : BTG80051  
**OEM No** : BrakingTech Only  
 Application : Hydraulic Caliper  
 Description : Hydraulic Piston  
 1- BTT410 Piston (Ø68 x 63.50 mm)



**Kit No** : BTG80053  
**OEM No** : BrakingTech Only  
 Application : Hydraulic Caliper  
 Description : Hydraulic Piston  
 1- BTT412 Piston (Ø68 x 62 mm.)



**Kit No** : BTG80055  
**OEM No** : BrakingTech Only  
 Application : Hydraulic Caliper  
 Description : Hydraulic Piston  
 1- BTT414 Piston (Ø68 x 48 mm.)



**Kit No** : BTG80056  
**OEM No** : BrakingTech Only  
 Application : Hydraulic Caliper  
 Description : Hydraulic Piston  
 1- BTT417 Piston (Ø55 x 56 mm)



**Kit No** : BTG80057  
**OEM No** : BrakingTech Only  
 Application : Hydraulic Caliper  
 Description : Hydraulic Piston  
 1- BTT416 Piston (Ø57 x 54 mm)



**Kit No** : BTG80058  
**OEM No** : BrakingTech Only  
 Application : Hydraulic Caliper  
 Description : Hydraulic Caliper Piston  
 1- BTT417 Piston (Ø45 x 51 mm)

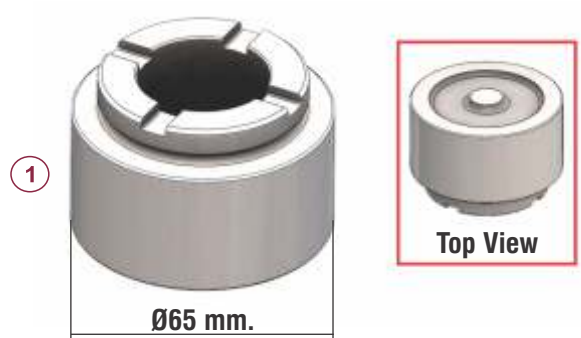

**Kit No** : BTG80059  
**OEM No** : BrakingTech Only  
 Application : Hydraulic Caliper  
 Description : Hydraulic Caliper Piston  
 1- BTT418 Piston (Ø65 x 42.50 mm)



**Kit No** : BTG80060  
**OEM No** : BrakingTech Only  
 Application : Hydraulic Caliper  
 Description : Hydraulic Piston  
 1- BTT419 Piston (Ø44 x 58 mm.)



**Kit No** : BTG80061  
**OEM No** : BrakingTech Only  
 Application : Hydraulic Caliper  
 Description : Hydraulic Piston  
 1- BTT420 Piston (Ø45 x 31 mm.)



**Kit No** : BTG80062  
**OEM No** : BrakingTech Only  
 Application : Hydraulic Caliper  
 Description : Hydraulic Piston  
 1- BTT421 Piston (Ø48 x 29 mm.)

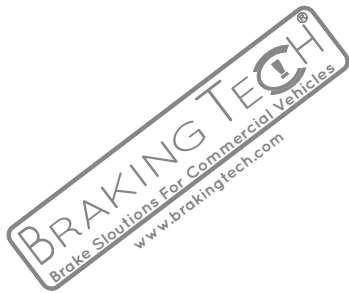

**Kit No** : BTG80064  
**OEM No** : BrakingTech Only  
 Application : Hydraulic Caliper  
 Description : Hydraulic Metal Ring  
 1- BTT413 Metal Ring (Ø34.50 x Ø10.70 x 6 mm.)



**Kit No** : BTG80066  
**OEM No** : BrakingTech Only  
 Application : Hydraulic Caliper  
 Description : Metal Tap  
 1- BTS123 Metal Tap (Ø45.50 x 8.50 mm.)



**Kit No** : BTG80063  
**OEM No** : BrakingTech Only  
 Application : Hydraulic Caliper  
 Description : Shaft Groove Plate  
 1- BTT422 Metal Plate

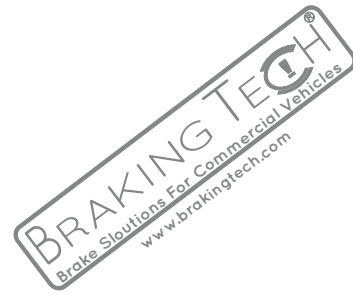

**Kit No** : BTG80065  
**OEM No** : BrakingTech Only  
 Application : Hydraulic Caliper  
 Description : Caliper Bushing  
 1- BTT424 Bush



**Kit No** : BTG80067  
**OEM No** : BrakingTech Only  
 Application : Hydraulic Caliper  
 Description : Metal Ring  
 1- BTS124 Metal Ring



**Kit No** : BTG80068  
**OEM No** : 105.3246.25  
 Application : Hydraulic - 20.5320.12/22/32/42  
 Description : Caliper Grease Nipple  
 1- BTT425 Grease Nipple



**Kit No** : BTG80070  
**OEM No** : A0004302283 /107 - A0004302283 -  
 0004302283 -000 430 2283  
 Application : Hydraulic Caliper  
 Description : Hydraulic Brake Master Cylinder Assembly  
 1- BT Brake Cylinder



**Kit No** : BTG80069  
**OEM No** : 000 420 24 44 - 0004202444 -  
 000 420 11 44  
 Application : ATE-Unimogs  
 Description : Caliper Seal Kit with Pad Shims  
 1- BT  
 2- BT



**Kit No** : BTG80046  
**OEM No** : BrakingTech Only  
 Application : Hydraulic Caliper  
 Description : Hydraulic Piston  
 1- BTT406 Piston (Ø51 x 60 mm.)

